

DHBT Series

DHBT 320B 1D5

Technical datasheet



Dereike blower performance curves

Vacuum selection diagram curve

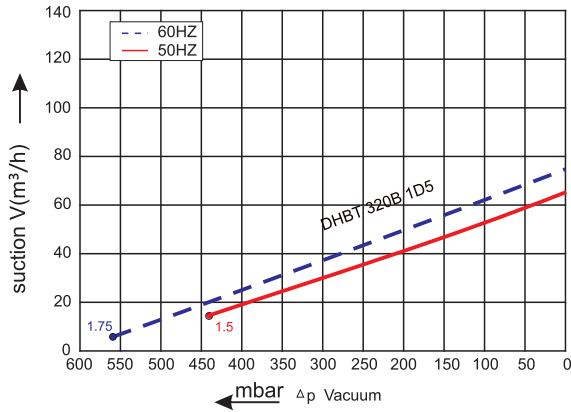

Compressor selection diagram curve

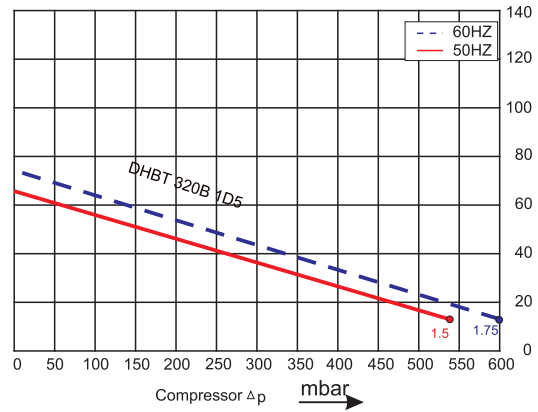

Dereike blower installation drawing

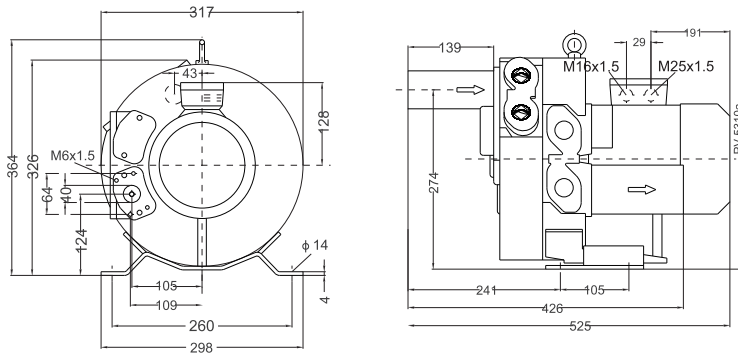

Dereike blower installation parameter

Model	Frequency	Output	Voltage	Current	Airflow	Pressure		Noise	Weight
						vacuum mbar	compressor mbar		
DHBT 320B 1D5	50	1.5	200-240△/345-415Y	7.5△/4.3Y	65	-440	540	59	30
	60	1.75	220-275△/380-480Y	7.5△/4.3Y	76	-560	600	63	30

The performance curves of Dereike blower is tested through below ways:

Under one atmospheric pressure, suck 15°C air and then you can calculate the data, of course allow 10% difference, and when the sucked air and surroundings temperature are not higher than 25°C, you still can get total pressure difference as the curves shows.